

KM. (HP)	OFC
1.000	13.00
1.100	13.00
1.200	36.00
1.300	36.00
1.400	31.00
1.500	31.00
1.600	31.00
1.700	18.00
1.800	21.00
1.900	22.00
2.000	19.00
2.100	25.00
2.200	31.00
2.300	45.00
2.400	23.00
2.500	27.00
2.600	33.00
2.700	14.00
2.800	31.00
2.900	29.00
3.000	39.00
3.100	43.00
3.200	43.00
3.300	45.00
3.400	46.00
3.500	42.00
3.600	43.00
3.700	43.00
3.800	30.00
3.900	25.00
4.000	25.00
4.100	25.00
4.200	27.00
4.300	24.00
4.400	31.00
4.500	43.00
4.600	43.00
4.700	43.00
4.800	42.00
4.900	41.00
5.000	41.00
5.100	33.00
5.200	33.00
5.300	32.00
5.400	32.00
5.500	31.00

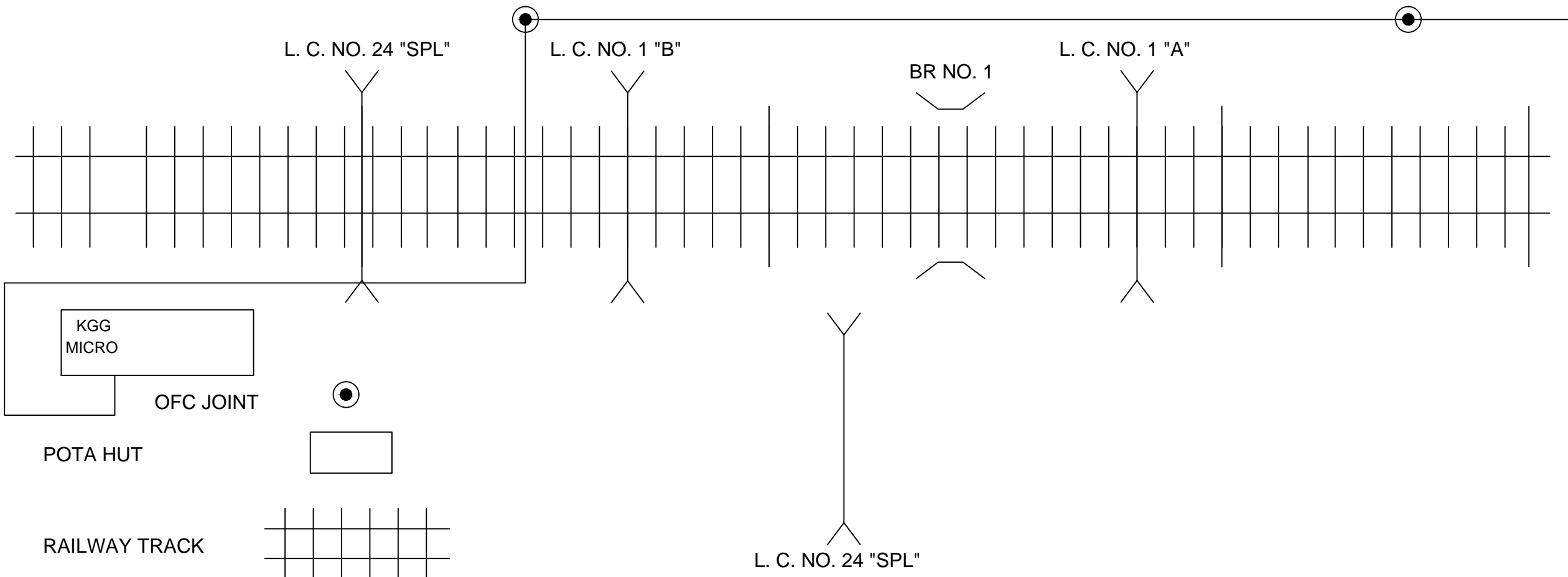

OFC ROUTE DIAGRAM BETWEEN SPJ TO KGG SECTION SPJ DIVISION M/S, DKC PROJECT PVT. LTD. KOLKATA W. B.				

KM. (HP)	OFC
5.600	33.00
5.700	33.00
5.800	28.00
5.900	28.00
6.000	29.00
6.100	28.00
6.200	32.00
6.300	25.00
6.400	25.00
6.500	26.00
6.600	28.00
6.700	30.00
6.800	30.00
6.900	28.00
7.000	29.00
7.100	88.00
7.200	28.00
7.300	34.00
7.400	32.00
7.500	32.00
7.600	32.00
7.700	26.00
7.800	25.00
7.900	27.00
8.000	27.00
8.100	34.00
8.200	34.00
8.300	26.00
8.400	26.00
8.500	25.00
8.600	26.00
8.700	25.00
8.800	25.00
8.900	24.00
9.000	39.00
9.100	33.00
9.200	33.00
9.300	33.00
9.400	30.00
9.500	30.00
9.600	29.00
9.700	33.00
9.800	33.00
9.900	34.00
10.000	29.00
10.100	50.00

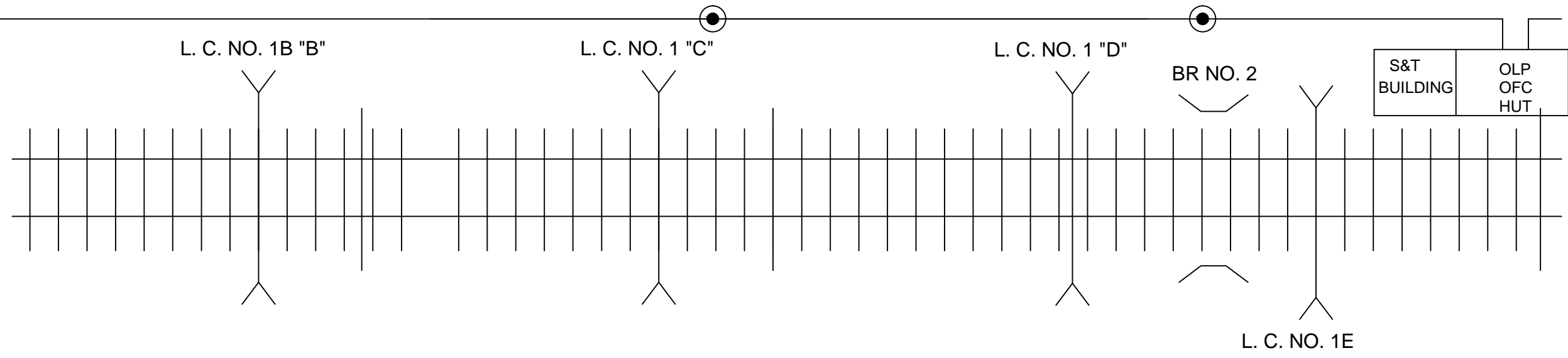

- OFC JOINT
- POTA HUT
- RAILWAY TRACK
- CABLE ROUTE
- LEVEL CROSSING
- CULUVERT/ROB

OFC ROUTE DIAGRAM BETWEEN SPJ TO KGG SECTION SPJ DIVISION M/S, DKC PROJECT PVT. LTD. KOLKATA W. B.				

KM. (HP)	OFC
10.200	44.00
10.300	34.00
10.400	34.00
10.500	36.00
10.600	35.00
10.700	35.00
10.800	33.00
10.900	32.00
11.000	24.00
11.100	36.00
11.200	35.00
11.300	35.00
11.400	36.00
11.500	36.00
11.600	35.00
11.700	34.00
11.800	31.00
11.900	34.00
12.000	42.00
12.100	32.00
12.200	57.00
12.300	55.00
12.400	46.00
12.500	48.00
12.600	30.00
12.700	27.00
12.800	31.00
12.900	34.00
13.000	38.00
13.100	32.00
13.200	31.00
13.300	28.00
13.400	38.00
13.500	27.00
13.600	30.00
13.700	39.00
13.800	32.00
13.900	31.00
14.000	31.00
14.100	30.00
14.200	26.00
14.300	23.00
14.400	22.00
14.500	25.00
14.600	29.00
14.700	28.00
14.800	27.00
14.900	25.00
15.000	30.00
15.100	30.00

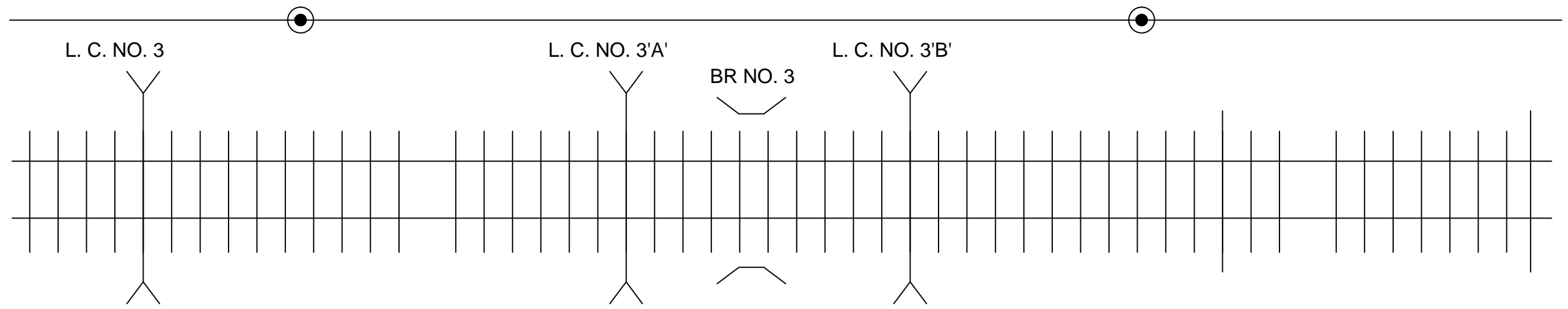

OFC JOINT

POTA HUT

RAILWAY TRACK

CABLE ROUTE

LEVEL CROSSING

CULUVERT/ROB

OFC ROUTE DIAGRAM BETWEEN SPJ TO KGG SECTION SPJ DIVISION M/S, DKC PROJECT PVT. LTD. KOLKATA W. B.				

KM. (HP)	OFC
15.200	29.00
15.300	30.00
15.400	26.00
15.500	30.00
15.600	28.00
15.700	31.00
15.800	31.00
15.900	39.00
16.000	33.00
16.100	34.00
16.200	24.00
16.300	30.00
16.400	29.00
16.500	31.00
16.600	30.00
16.700	29.00
16.800	30.00
16.900	26.00
17.000	25.00
17.100	30.00
17.200	31.00
17.300	32.00
17.400	29.00
17.500	28.00
17.600	33.00
17.700	32.00
17.800	31.00
17.900	31.00
18.000	35.00
18.100	89.00
18.200	29.00
18.300	24.00
18.400	40.00
18.500	53.00
18.600	45.00
18.700	39.00
18.800	51.00
18.900	57.00
19.000	82.00
19.100	11.00
19.200	65.00
19.300	57.00
19.400	59.00
19.500	58.00
19.600	54.00
19.700	54.00
19.800	56.00
19.900	55.00
20.000	53.00
20.100	52.00

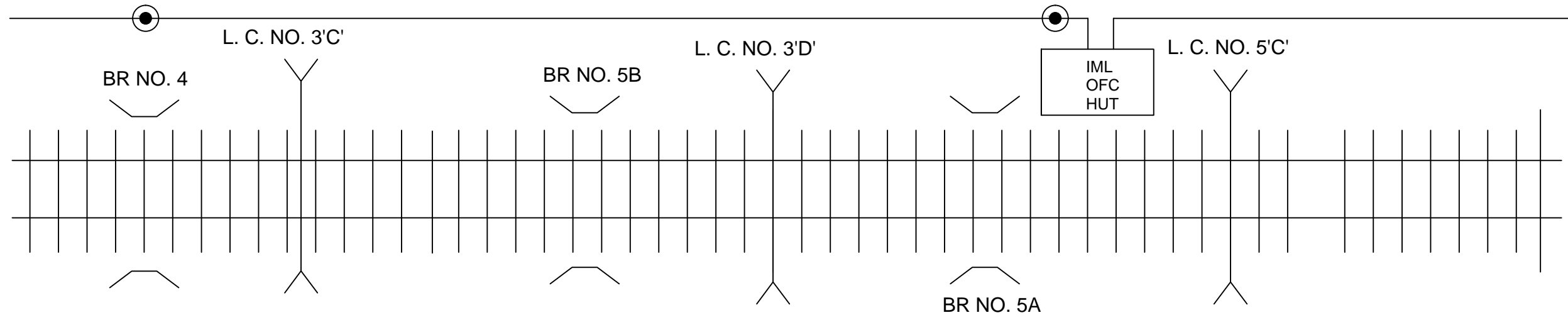

OFC JOINT



POTA HUT



RAILWAY TRACK

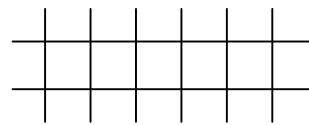

CABLE ROUTE

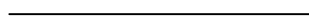

LEVEL CROSSING

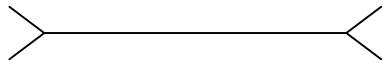

CULUVERT/ROB

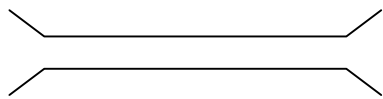

**OFC ROUTE DIAGRAM BETWEEN SPJ TO KGG SECTION SPJ DIVISION
M/S, DKC PROJECT PVT. LTD. KOLKATA W. B.**

KM. (HP)	OFC
20.200	55.00
20.300	54.00
20.400	53.00
20.500	51.00
20.600	50.00
20.700	52.00
20.800	54.00
20.900	53.00
21.000	54.00
21.100	55.00
21.200	52.00
21.300	58.00
21.400	52.00
21.500	52.00
21.600	00.00
21.700	00.00
21.800	16.00
21.900	21.00
22.000	24.00
22.100	25.00
22.200	24.00
22.300	23.00
22.400	26.00
22.500	33.00
22.600	40.00
22.700	39.00
22.800	38.00
22.900	37.00
23.000	46.00
23.100	46.00
23.200	47.00
23.300	44.00
23.400	45.00
23.500	38.00
23.600	36.00
23.700	35.00
23.800	41.00
23.900	42.00
24.000	18.00
24.100	15.00
24.200	14.00
24.300	14.00
24.400	14.00
24.500	13.00
24.600	14.00
24.700	13.00
24.800	26.00
24.900	29.00
25.000	26.00
25.100	33.00

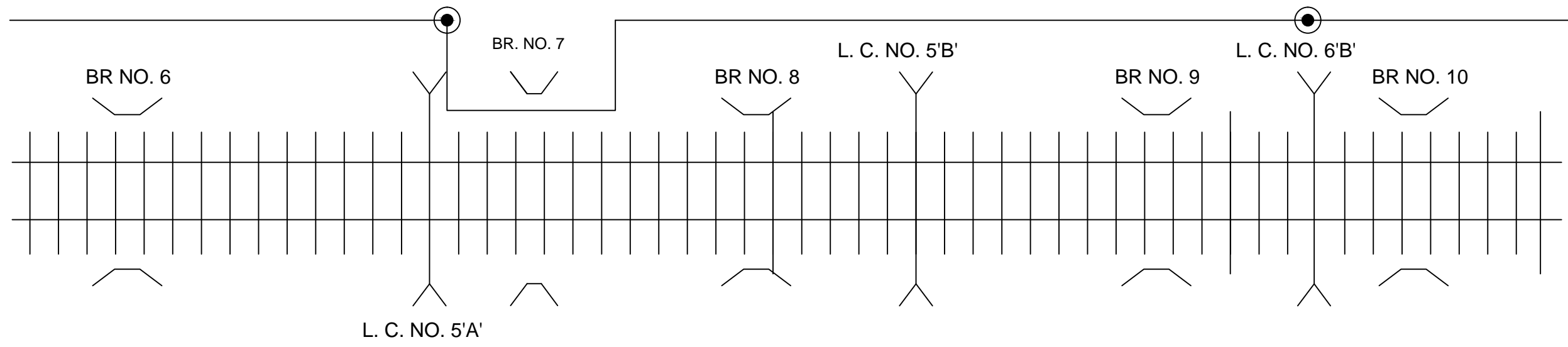

- OFC JOINT
- POTA HUT
- RAILWAY TRACK
- CABLE ROUTE
- LEVEL CROSSING
- CULUVERT/ROB

OFC ROUTE DIAGRAM BETWEEN SPJ TO KGG SECTION SPJ DIVISION M/S, DKC PROJECT PVT. LTD. KOLKATA W. B.				

KM. (HP)	OFC
25.200	35.00
25.300	30.00
25.400	20.00
25.500	13.00
25.600	21.00
25.700	20.00
25.800	21.00
25.900	13.00
26.000	13.00
26.100	13.00
26.200	13.00
26.300	31.00
26.400	32.00
26.500	29.00
26.600	30.00
26.700	28.00
26.800	36.00
26.900	37.00
27.000	36.00
27.100	42.00
27.200	32.00
27.300	31.00
27.400	24.00
27.500	49.00
27.600	44.00
27.700	57.00
27.800	56.00
27.900	46.00
28.000	39.00
28.100	24.00
28.200	36.00
28.300	40.00
28.400	38.00
28.500	38.00
28.600	24.00
28.700	41.00
28.800	32.00
28.900	53.00
29.000	35.00
29.100	31.00
29.200	31.00
29.300	32.00
29.400	34.00
29.500	26.00
29.600	25.00
29.700	23.00
29.800	27.00
29.900	18.00
30.000	19.00
30.100	26.00

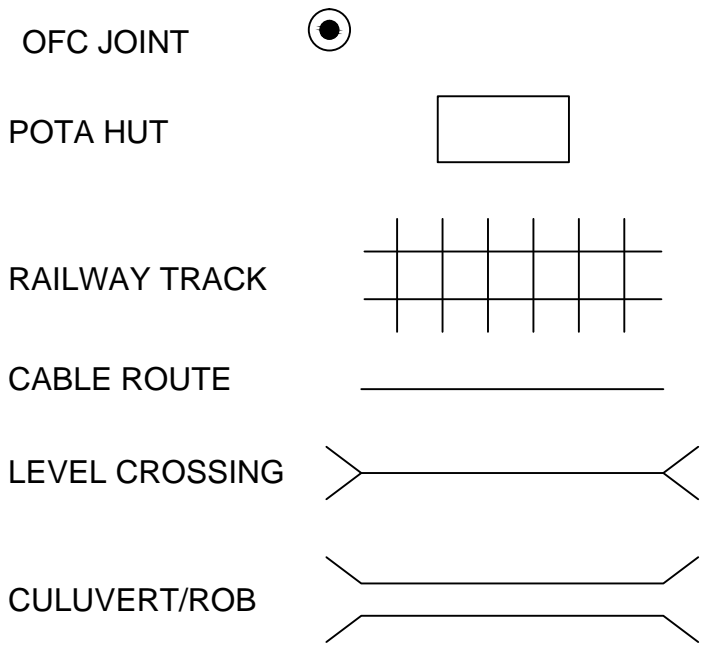
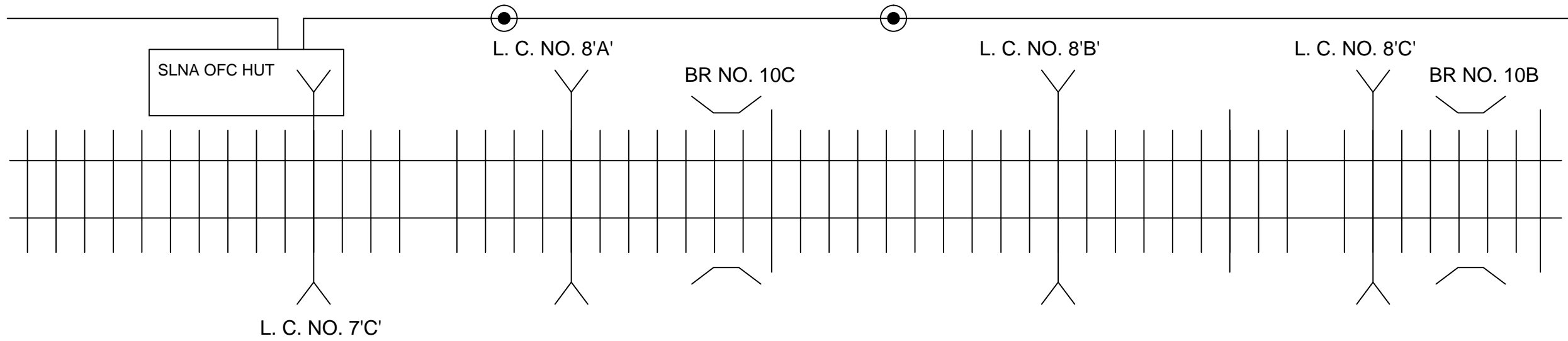

OFC ROUTE DIAGRAM BETWEEN SPJ TO KGG SECTION SPJ DIVISION M/S, DKC PROJECT PVT. LTD. KOLKATA W. B.				

KM. (HP)	OFC
30.200	21.00
30.300	16.00
30.400	22.00
30.500	23.00
30.600	23.00
30.700	24.00
30.800	24.00
30.900	29.00
31.000	28.00
31.100	28.00
31.200	28.00
31.300	21.00
31.400	21.00
31.500	19.00
31.600	22.00
31.700	26.00
31.800	25.00
31.900	27.00
32.000	27.00
32.100	21.00
32.200	20.00
32.300	25.00
32.400	22.00
32.500	24.00
32.600	19.00
32.700	20.00
32.800	28.00
32.900	18.00
33.000	22.00
33.100	21.00
33.200	21.00
33.300	22.00
33.400	35.00
33.500	36.00
33.600	26.00
33.700	24.00
33.800	24.00
33.900	18.00
34.000	35.00
34.100	32.00
34.200	32.00
34.300	31.00
34.400	31.00
34.500	32.00
34.600	32.00
34.700	32.00
34.800	31.00
34.900	31.00
35.000	33.00
35.100	33.00

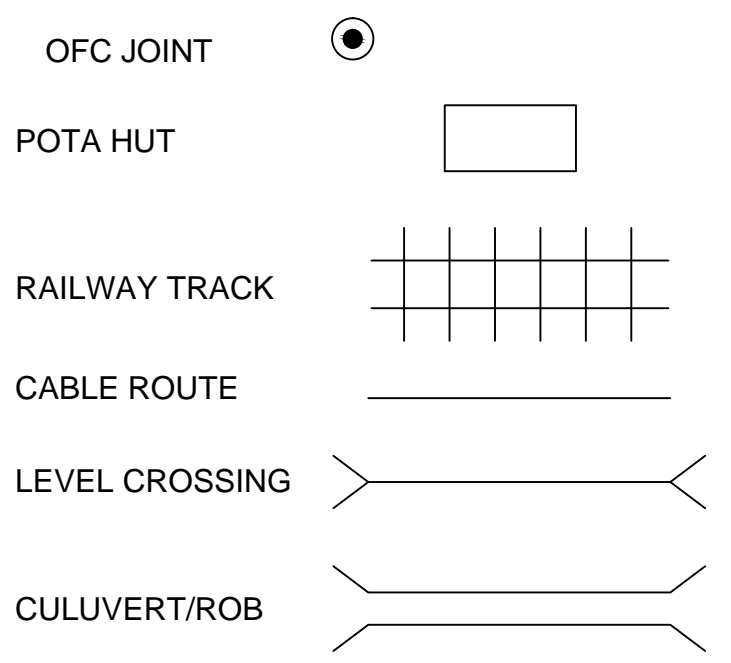
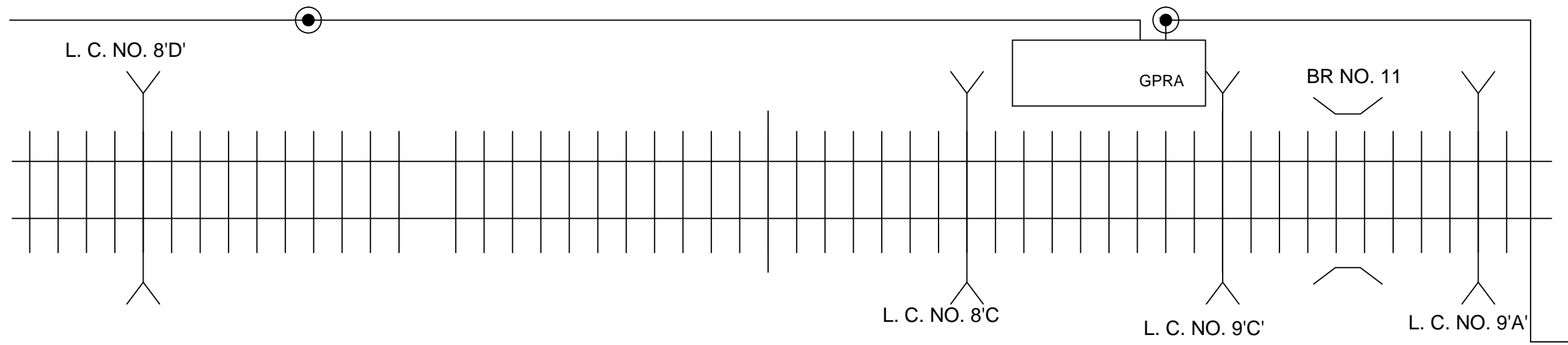

OFC ROUTE DIAGRAM BETWEEN SPJ TO KGG SECTION SPJ DIVISION M/S, DKC PROJECT PVT. LTD. KOLKATA W. B.				

KM. (HP)	OFC
35.200	34.00
35.300	33.00
35.400	34.00
35.500	34.00
35.600	34.00
35.700	33.00
35.800	33.00
35.900	35.00
36.000	39.00
36.100	42.00
36.200	44.00
36.300	42.00
36.400	36.00
36.500	27.00
36.600	24.00
36.700	24.00
36.800	21.00
36.900	21.00
37.000	18.00
37.100	18.00
37.200	18.00
37.300	25.00
37.400	27.00
37.500	29.00
37.600	43.00
37.700	43.00
37.800	42.00
37.900	42.00
38.000	43.00
38.100	43.00
38.200	52.00
38.300	53.00
38.400	53.00
38.500	53.00
38.600	53.00
38.700	51.00
38.800	51.00
38.900	51.00
39.000	30.00
39.100	46.00
39.200	46.00
39.300	41.00
39.400	55.00
39.500	66.00
39.600	66.00
39.700	39.00
39.800	32.00
39.900	44.00
40.000	51.00
40.100	59.00

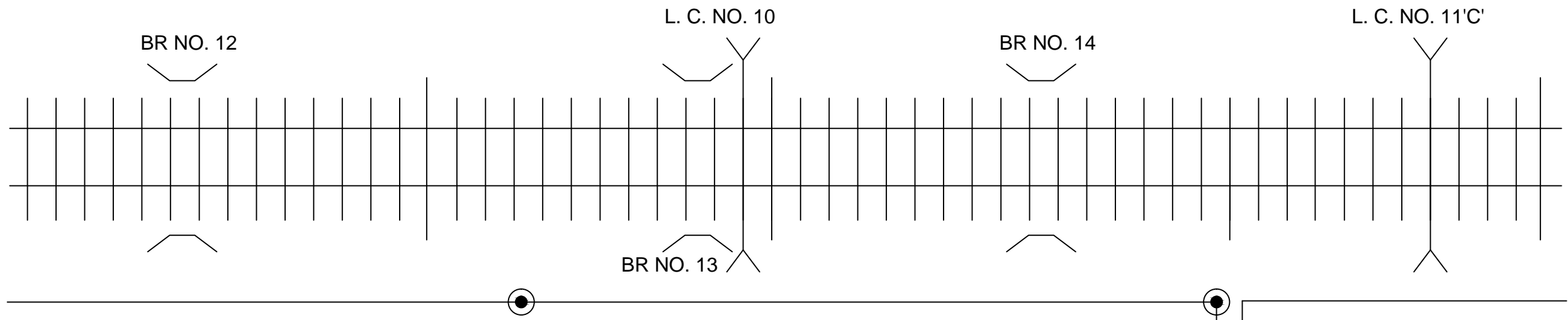

OFC JOINT

POTA HUT

RAILWAY TRACK

CABLE ROUTE

LEVEL CROSSING

CULUVERT/ROB

OFC ROUTE DIAGRAM BETWEEN SPJ TO KGG SECTION SPJ DIVISION M/S, DKC PROJECT PVT. LTD. KOLKATA W. B.				

KM. (HP)	OFC
40.200	59.00
40.300	59.00
40.400	58.00
40.500	10.00
40.600	21.00
40.700	28.00
40.800	18.00
40.900	29.00
41.000	34.00
41.100	29.00
41.200	28.00
41.300	29.00
41.400	28.00
41.500	00.00
41.600	26.00
41.700	28.00
41.800	25.00
41.900	23.00
42.000	13.00
42.100	16.00
42.200	28.00
42.300	28.00
42.400	28.00
42.500	42.00
42.600	44.00
42.700	43.00
42.800	38.00
42.900	21.00
43.000	23.00
43.100	23.00
43.200	25.00
43.300	25.00
43.400	44.00
43.500	42.00
43.600	44.00
43.700	44.00
43.800	40.00
43.900	39.00
44.000	42.00
44.100	42.00
44.200	43.00
44.300	46.00
44.400	42.00
44.500	44.00
44.600	42.00
44.700	43.00
44.800	44.00
44.900	30.00
45.000	29.00
45.100	28.00

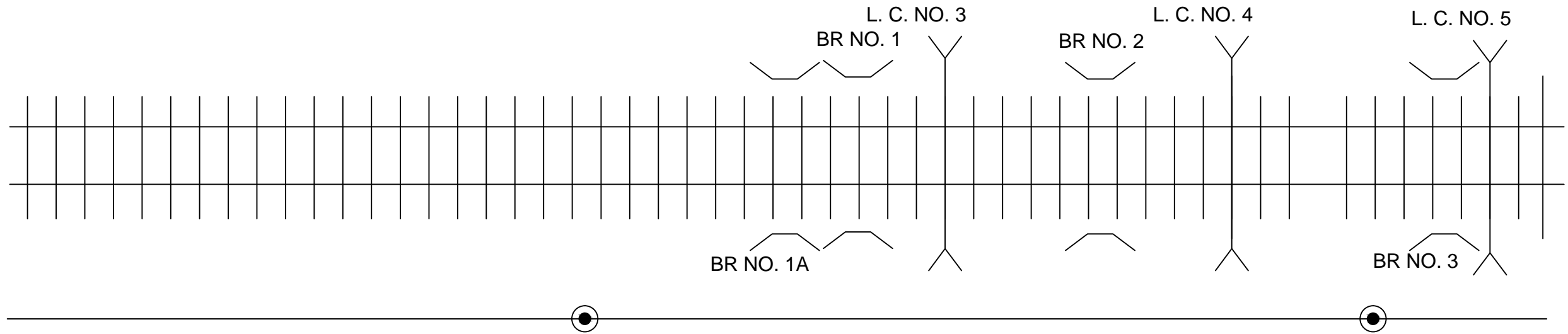

OFC JOINT



POTA HUT



RAILWAY TRACK

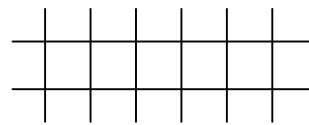

CABLE ROUTE

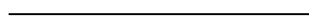

LEVEL CROSSING

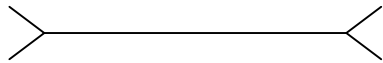

CULUVERT/ROB

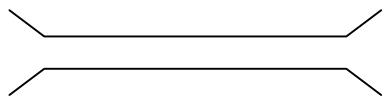

**OFC ROUTE DIAGRAM BETWEEN SPJ TO KGG SECTION SPJ DIVISION
M/S, DKC PROJECT PVT. LTD. KOLKATA W. B.**

KM. (TP)	OFC
45.200	30.00
45.300	29.00
45.400	29.00
45.500	28.00
45.600	28.00
45.700	30.40
45.800	30.00
45.900	30.00
46.000	36.00
46.100	35.00
46.200	36.00
46.300	38.00
46.400	37.00
46.500	44.00
46.600	47.00
46.700	48.00
46.800	44.00
46.900	46.00
47.000	41.00
47.100	43.00
47.200	47.00
47.300	47.00
47.400	44.00
47.500	42.00
47.600	49.00
47.700	45.00
47.800	45.00
47.900	44.90
48.000	44.60
48.100	48.90
48.200	48.00
48.300	43.00
48.400	45.00
48.500	52.00
48.600	55.00
48.700	50.00
48.800	00.00
48.900	00.00
49.000	53.00
49.100	52.80
49.200	37.80
49.300	40.00
49.400	38.00
49.500	38.00
49.600	35.10
49.700	35.00
49.800	34.90
49.900	63.50
50.000	63.20
50.100	65.50

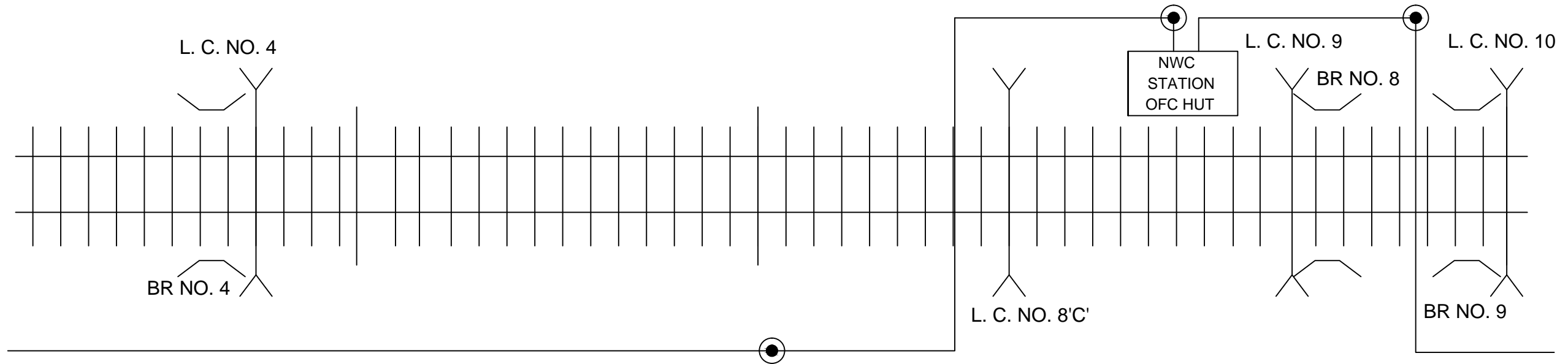

OFJ JOINT

POTA HUT

RAILWAY TRACK

CABLE ROUTE

LEVEL CROSSING

CULUVERT/ROB

**OFC ROUTE DIAGRAM BETWEEN SPJ TO KGG SECTION SPJ DIVISION
M/S, DKC PROJECT PVT. LTD. KOLKATA W. B.**

KM. (HP)	OFC
50.200	42.80
50.300	42.40
50.400	42.00
50.500	40.60
50.600	40.40
50.700	41.90
50.800	41.70
50.900	30.00
51.000	41.60
51.100	41.40
51.200	41.60
51.300	41.90
51.400	41.80
51.500	39.00
51.600	41.90
51.700	41.70
51.800	41.60
51.900	43.00
52.000	42.30
52.100	41.80
52.200	26.60
52.300	24.10
52.400	16.90
52.500	15.00
52.600	34.00
52.700	33.90
52.800	33.60
52.900	29.00
53.000	24.90
53.100	23.80
53.200	22.20
53.300	21.10
53.400	20.50
53.500	20.90
53.600	27.70
53.700	26.10
53.800	25.00
53.900	24.70
54.000	29.60
54.100	32.60
54.200	22.90
54.300	25.50
54.400	26.30
54.500	26.30
54.600	23.20
54.700	21.10
54.800	14.40
54.900	20.10
55.000	21.90
55.100	19.20

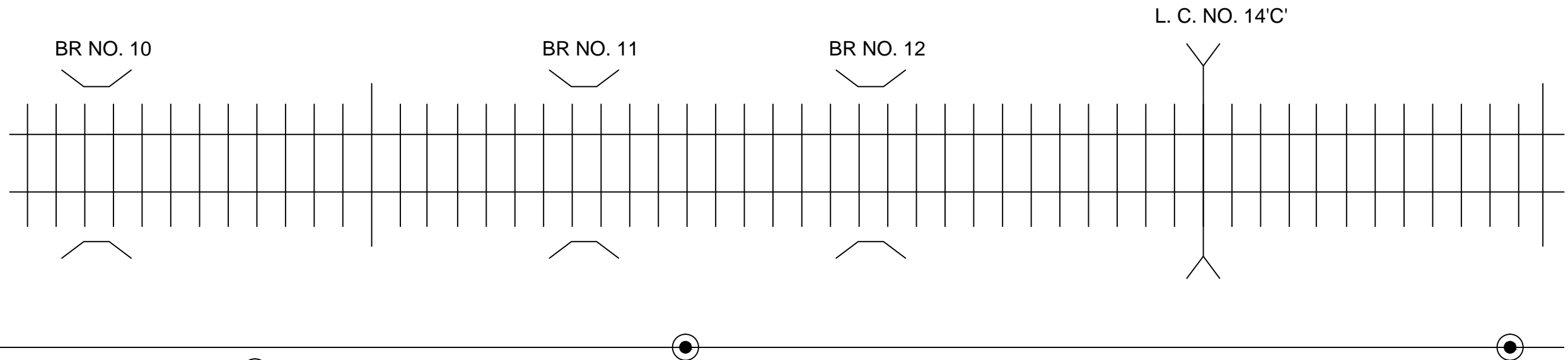

OFC JOINT

POTA HUT

RAILWAY TRACK

CABLE ROUTE

LEVEL CROSSING

CULVERT/ROB

**OFC ROUTE DIAGRAM BETWEEN SPJ TO KGG SECTION SPJ DIVISION
M/S, DKC PROJECT PVT. LTD. KOLKATA W. B.**

KM. (HP)	OFC
55.200	21.00
55.300	21.30
55.400	23.50
55.550	25.50
55.600	21.70
55.700	34.70
55.800	34.00
55.900	38.00
56.000	38.70
56.100	30.00
56.200	31.70
56.300	32.00
56.400	50.00
56.500	28.70
56.600	29.00
56.700	54.20
56.800	58.10
56.900	50.10
57.000	31.10
57.100	48.10
57.200	26.60
57.300	22.00
57.400	23.80
57.500	34.10
57.600	33.00
57.700	67.10
57.800	57.70
57.900	69.00
58.000	54.70
58.100	20.50
58.200	24.50
58.300	75.20
58.400	74.50
58.500	73.40
58.600	34.70
58.700	27.70
58.800	24.40
58.900	29.60
59.000	27.20
59.100	21.90
59.200	20.50
59.300	20.20
59.400	25.00
59.500	26.70
59.600	26.80
59.700	21.10
59.800	14.40
59.900	20.10
60.000	21.90
60.100	19.20

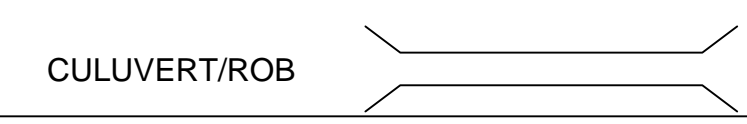
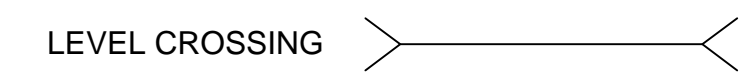
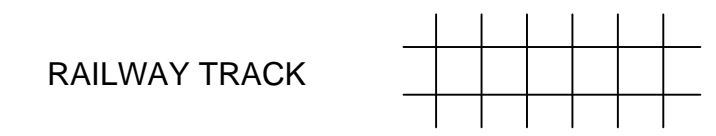
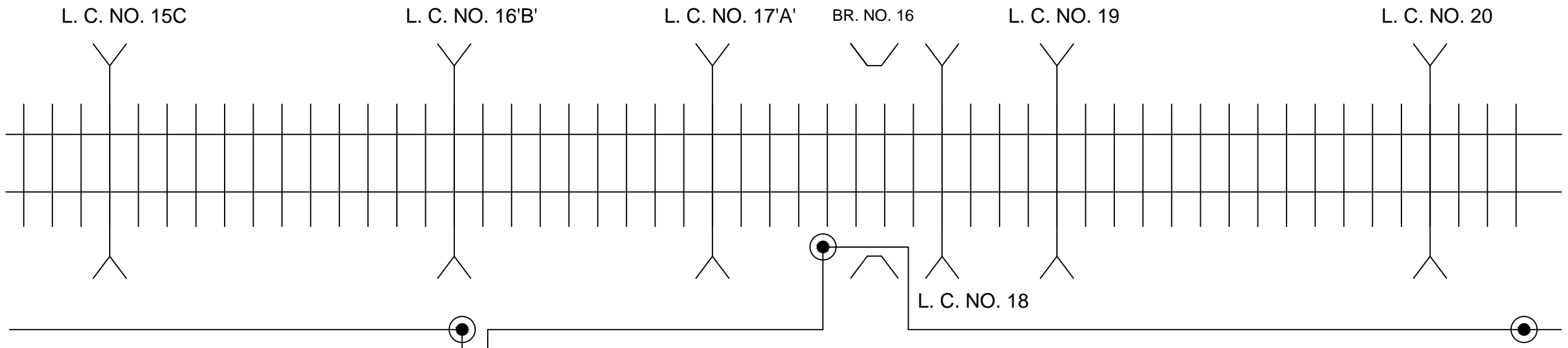

OFC ROUTE DIAGRAM BETWEEN SPJ TO KGG SECTION SPJ DIVISION M/S, DKC PROJECT PVT. LTD. KOLKATA W. B.				

KM. (HP)	OFC
60.200	21.00
60.300	21.30
60.400	23.50
60.600	25.50
60.600	21.70
60.700	34.70
60.800	34.00
60.900	38.00
61.000	38.70
61.100	30.00
61.200	31.70
61.300	32.00
61.400	50.00
61.500	28.70
61.600	29.00
61.700	54.20
61.800	58.10
61.900	50.10
62.000	31.10
62.100	48.10
62.200	26.60
62.300	22.00
62.400	23.80
62.500	34.10
62.600	33.00
62.700	67.10
62.800	57.70
62.900	69.00
63.000	54.70
63.100	20.50
63.200	24.50
63.300	75.20
63.400	74.50
63.500	73.40
63.600	34.70
63.700	27.70
63.800	24.40
63.900	29.60
64.000	27.20
64.100	21.90
64.200	20.50
64.300	20.20
64.400	25.00
64.500	26.70
64.600	26.80
64.700	21.10
64.800	14.40
64.900	20.10
65.000	21.90
65.100	19.20
65.200	21.90
65.300	19.20
65.400	21.90
65.500	19.20
65.600	21.90
65.700	19.20
65.800	21.90
65.900	19.20

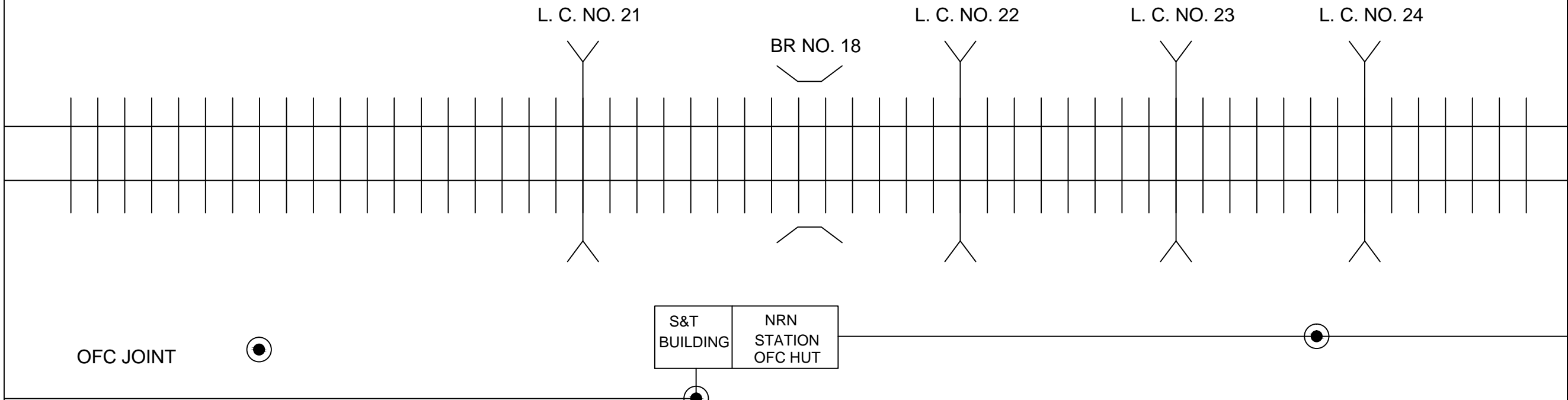

POTA HUT



RAILWAY TRACK

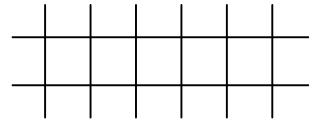

CABLE ROUTE

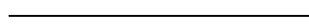

LEVEL CROSSING

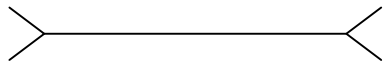

CULUVERT/ROB

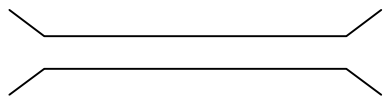

**OFC ROUTE DIAGRAM BETWEEN SPJ TO KGG SECTION SPJ DIVISION
M/S, DKC PROJECT PVT. LTD. KOLKATA W. B.**

KM.(HP)	OFC
66.000	13.00
66.100	13.00
66.200	36.00
66.300	36.00
66.400	31.00
66.500	31.00
66.600	31.00
66.700	18.00
66.800	21.00
66.900	22.00
67.000	29.20
67.100	23.90
67.00	21.70
67.300	20.70
67.400	20.80
67.500	20.80
67.600	24.60
67.700	29.60
67.800	34.50
67.900	48.00
68.000	49.50
68.100	49.10
68.200	50.40
68.300	37.00
68.400	21.70
68.500	29.61
68.600	28.30
68.700	38.20
68.800	38.50
68.900	37.70
69.000	37.10
69.100	37.70
69.200	37.80
69.300	37.80
69.400	25.90
69.500	20.80
69.600	29.50
69.700	25.50
69.800	22.60
69.900	12.40
70.000	19.30
70.100	21.80
70.200	20.90
70.300	20.60
70.400	21.10
70.500	18.40

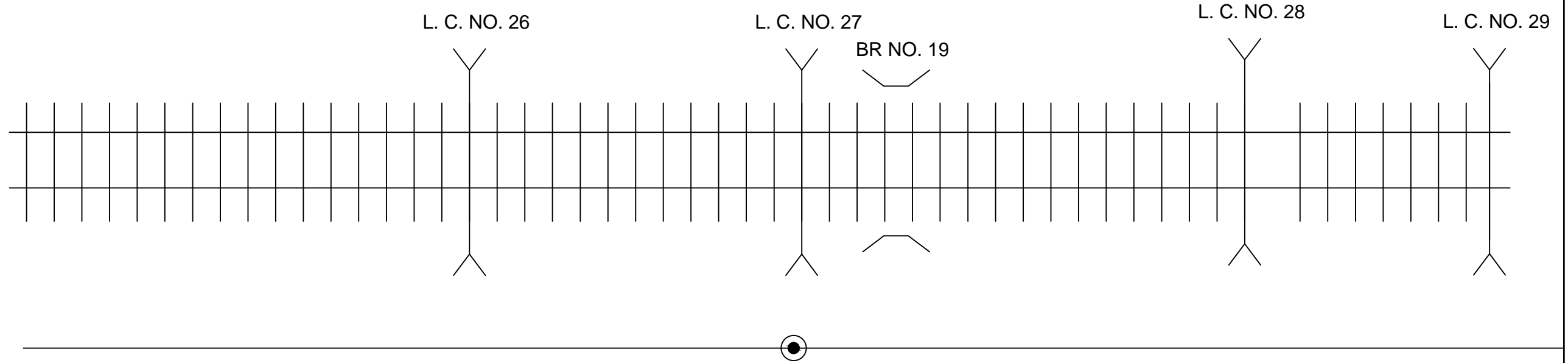

POTA HUT



RAILWAY TRACK

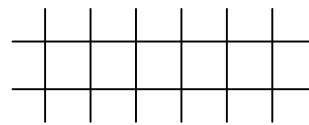

CABLE ROUTE

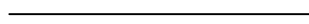

LEVEL CROSSING

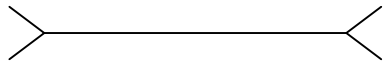

CULUVERT/ROB

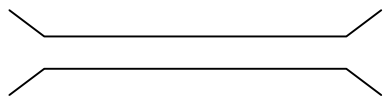

OFC JOINT



**OFC ROUTE DIAGRAM BETWEEN SPJ TO KGG SECTION SPJ DIVISION
M/S, DKC PROJECT PVT. LTD. KOLKATA W. B.**

KM.(HP)	OFC
70.600	18.70
70.700	19.70
70.800	13.00
70.900	22.10
71.000	23.20
71.100	33.20
71.000	23.10
71.300	30.60
71.400	27.80
71.500	28.80
71.600	25.60
71.700	27.70
71.800	18.30
71.900	17.10
72.000	19.30
72.100	26.10
72.200	38.50
72.300	37.70
72.400	40.00
72.500	34.00
72.600	39.30
72.700	35.30
72.800	27.50
72.900	35.00
73.000	35.00
73.100	36.00
73.200	36.10
73.300	38.80
73.400	38.70
73.500	38.60
73.600	38.80
73.700	36.10
73.800	38.60
73.900	38.80
74.000	38.20
74.100	32.16
74.200	30.80
74.300	37.20
74.400	38.50
74.500	36.00
74.600	28.30
74.740	25.90
74.800	27.70
74.900	26.00
75.000	25.80
75.100	20.10

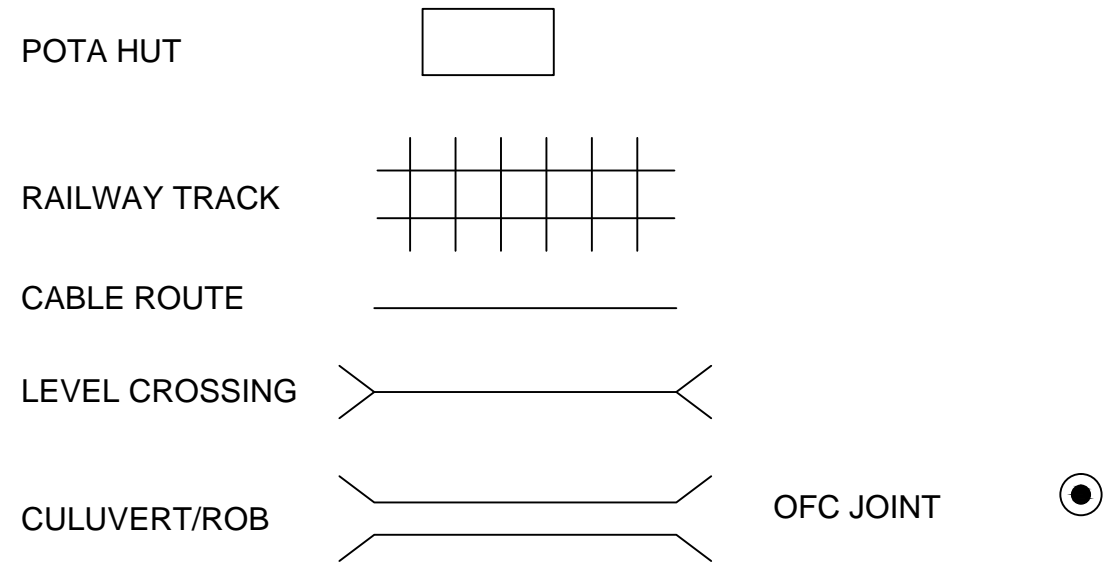
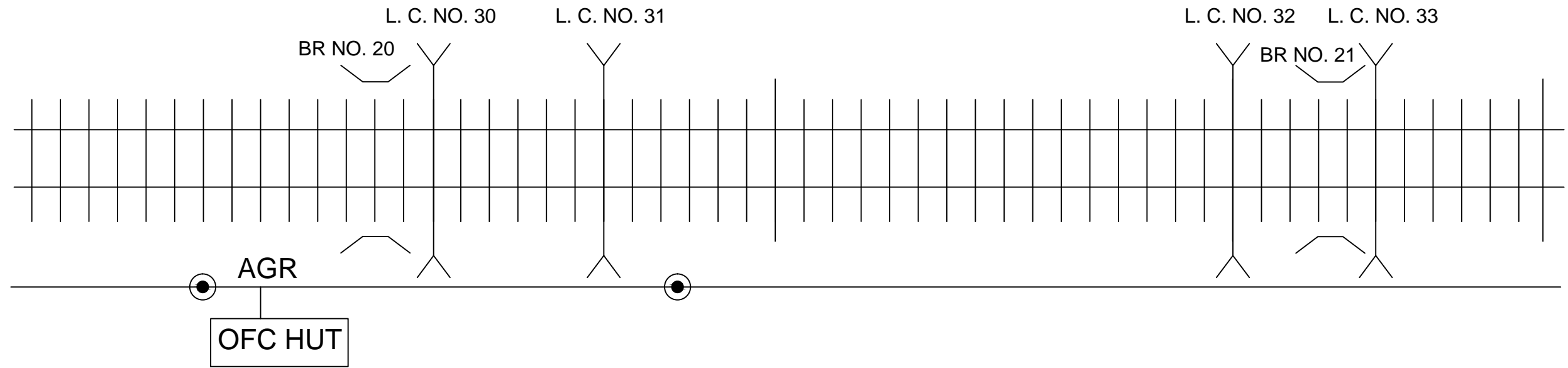

OFC ROUTE DIAGRAM BETWEEN SPJ TO KGG SECTION SPJ DIVISION M/S, DKC PROJECT PVT. LTD. KOLKATA W. B.				

KM. (HP)	OFC
75.200	18.70
75.300	19.70
75.400	13.00
75.500	22.10
75.600	23.20
75.700	33.20
75.800	23.10
75.900	30.60
76.000	27.80
76.100	28.80
76.200	25.60
76.300	27.70
76.400	18.30
76.500	17.10
76.600	19.30
76.700	26.10
76.800	38.50
76.900	37.70
77.000	40.00
77.100	34.00
77.200	39.30
77.300	35.30
77.400	27.50
77.500	35.00
77.600	35.00
77.700	36.00
77.800	36.10
77.900	38.80
78.000	38.70
78.100	38.60
78.200	38.80
78.300	36.10
78.400	38.60
78.500	38.80
78.600	38.20
78.780	32.16
78.800	30.80
78.900	37.20
79.000	38.50
79.100	36.00
79.200	28.30
79.300	25.90
79.400	27.70
79.500	26.00
79.600	25.80
79.700	20.10

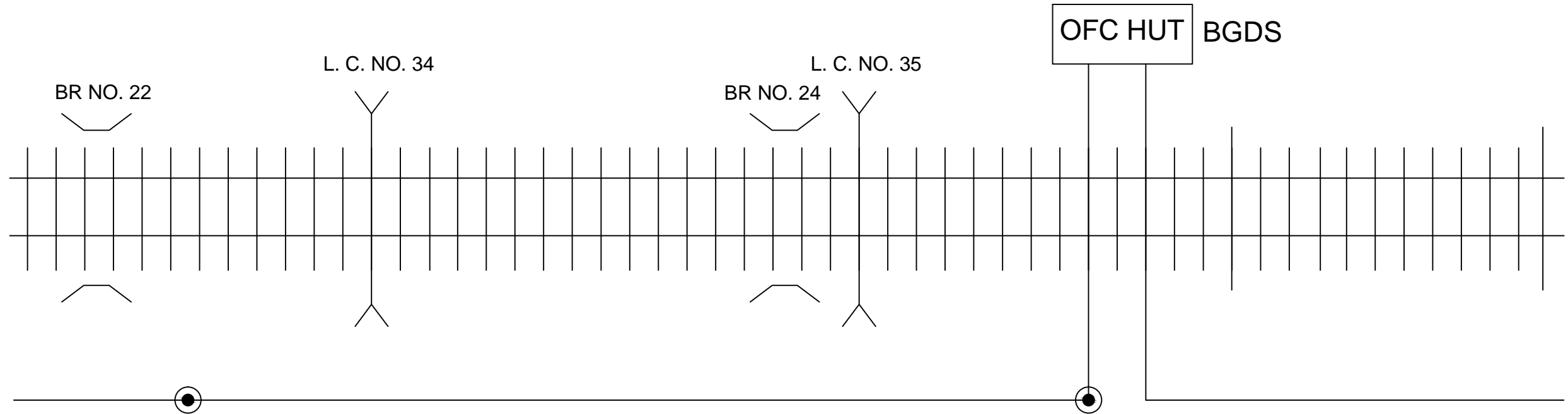

POTA HUT



RAILWAY TRACK

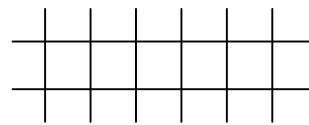

CABLE ROUTE

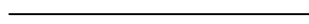

LEVEL CROSSING

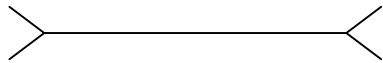

CULUVERT/ROB

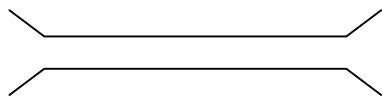

OFC JOINT



**OFC ROUTE DIAGRAM BETWEEN SPJ TO KGG SECTION SPJ DIVISION
M/S, DKC PROJECT PVT. LTD. KOLKATA W. B.**

KM. (HP)	OFC
79.800	18.70
79.900	19.70
80.000	13.00
80.100	13.00
80.200	22.10
80.300	23.20
80.400	16.20
80.500	17.10
80.600	16.60
80.700	14.80
80.800	18.80
80.900	15.60
81.000	17.70
81.100	18.30
81.200	17.10
81.300	19.30
81.400	16.10
81.500	18.50
81.600	17.70
81.700	14.00
81.800	14.00
81.900	19.30
82.000	15.30
82.100	17.50
82.200	15.00
82.300	15.00
82.400	16.00
82.500	16.10
82.600	18.80
82.700	18.70
82.800	18.60
82.900	18.80
83.000	16.10
83.100	18.60
83.200	18.80
83.300	18.20
83.400	15.16
83.500	16.80
83.600	14.20
83.700	13.50
83.800	19.00
83.900	26.30
84.000	17.00
84.100	17.70
84.200	12.00
84.300	14.80
84.400	14.10

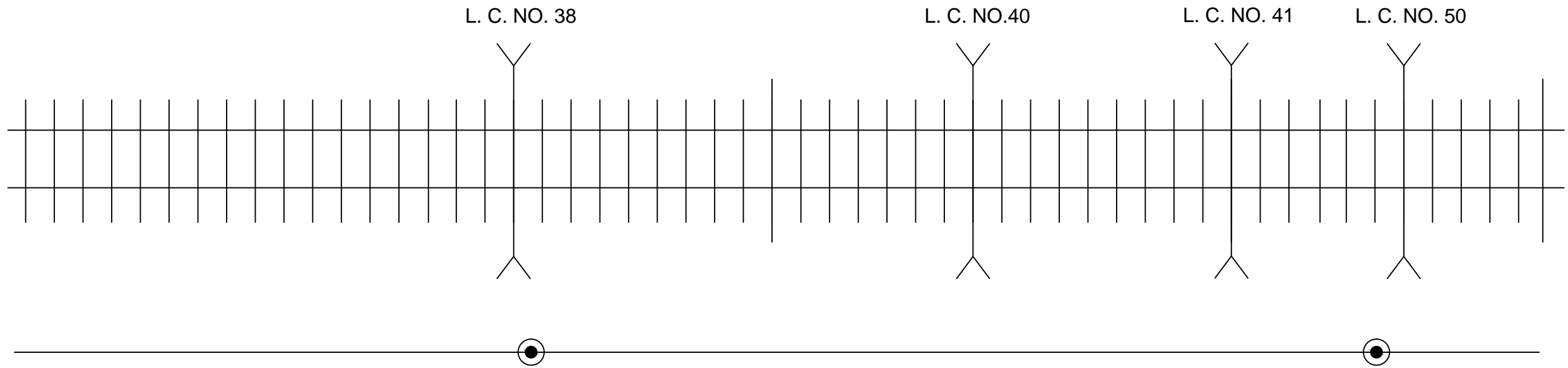

POTA HUT



RAILWAY TRACK

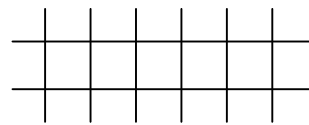

CABLE ROUTE

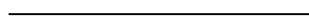

LEVEL CROSSING

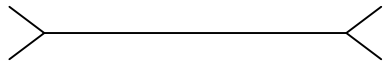

CULUVERT/ROB

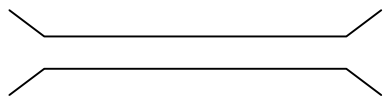

OFC JOINT



**OFC ROUTE DIAGRAM BETWEEN SPJ TO KGG SECTION SPJ DIVISION
M/S, DKC PROJECT PVT. LTD. KOLKATA W. B.**

KM. (HP)	OFC
84.500	18.70
84.600	19.70
84.700	13.00
84.800	13.00
84.900	14.10
85.000	15.10
85.100	14.20
85.200	15.20
85.300	14.10
85.400	15.60
85.500	17.80
85.600	15.80
85.700	16.60
85.800	17.70
85.900	18.30

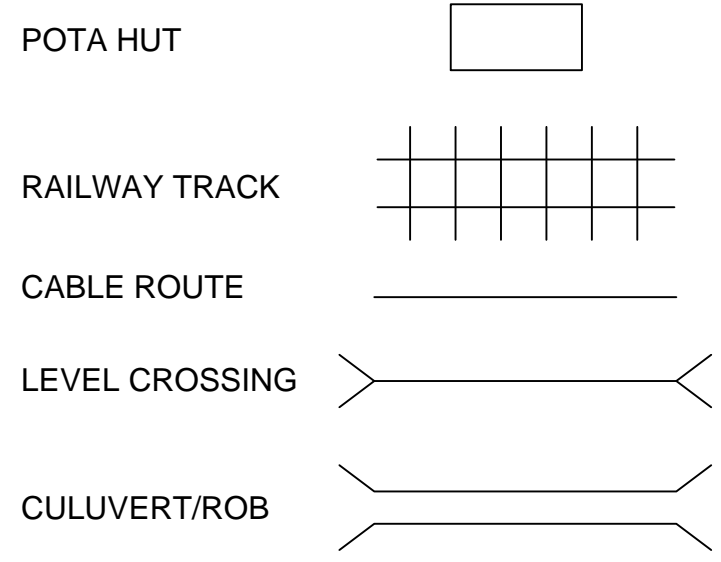
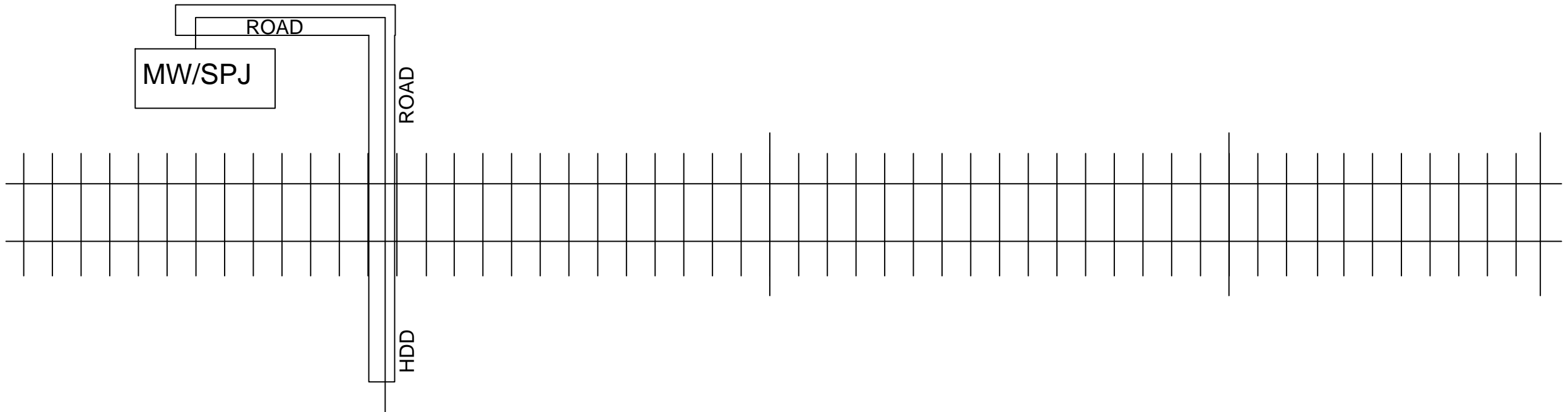

OFC JOINT

OFC ROUTE DIAGRAM BETWEEN SPJ TO KGG SECTION SPJ DIVISION M/S, DKC PROJECT PVT. LTD. KOLKATA W. B.				